

marzocchi
WWW.MARZOCCHI.COM

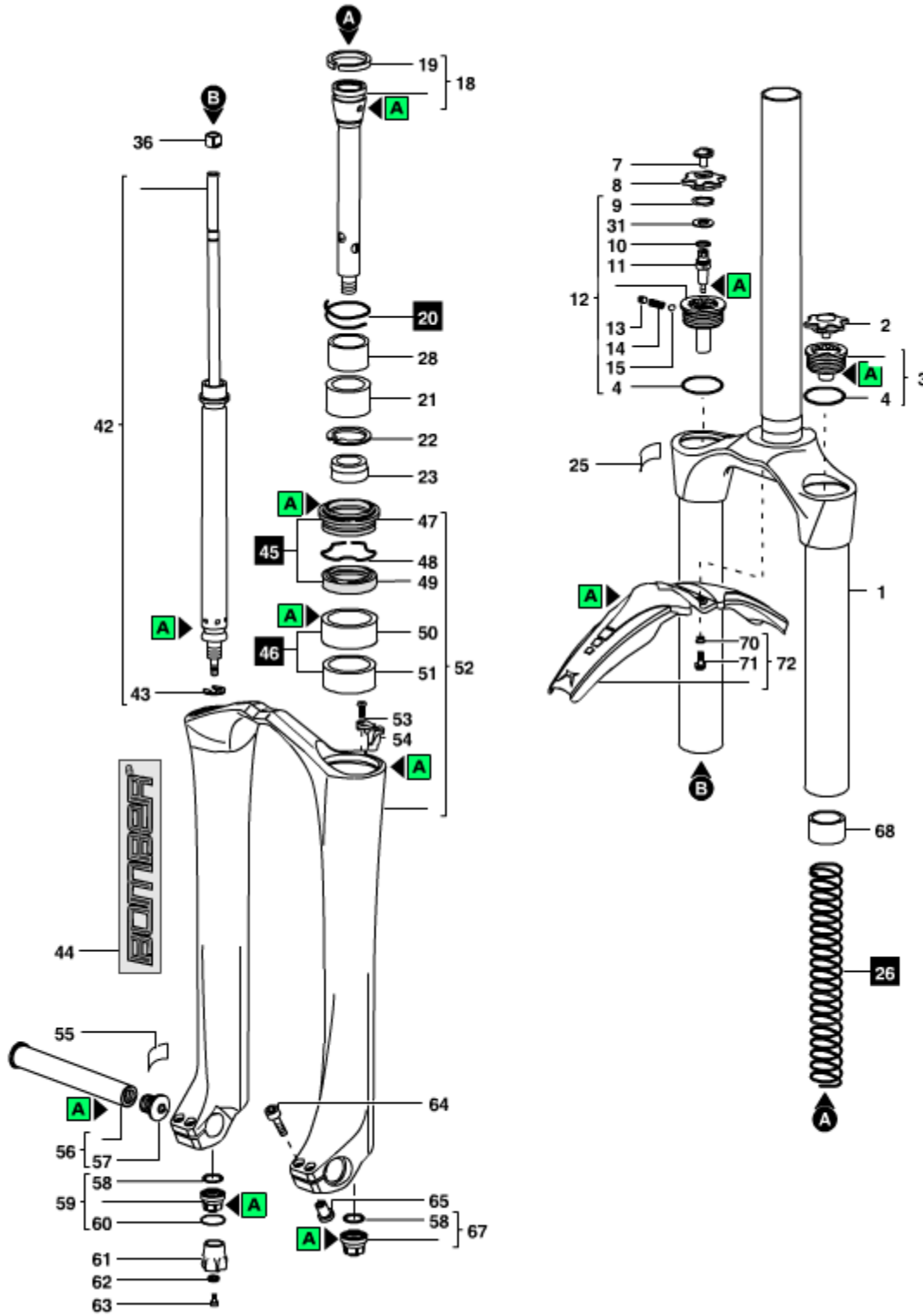

2006 - 66 Light

Technical instructions

Exploded view - 66 Light - 150

Rif. Code	Quantity
1 818370/E	1
1 818370/A	1
1 818370/R	1
2 549098LA	1
3 701296/C	1
4 528188	2
7 549097AC	1
8 549094LA	1
9 523294	1
10 528265	1
11 5321372	1
12 701288/C	1
13 520220KV	1
14 5141137>A	1
15 525007	1
20 5141461	1
21 509155	1
22 523078	1
23 512101	1
25 547713	1
25 547711	1
26 5141330/C	1
28 5181520	1
31 522472	1
36 5211421W>A	1
42 703747LA/C	1
43 523011	1
44 547717	1
44 547665	1
44 547690	1
47 533167	2
48 523236	2
49 528034>B	2
50 538038>A	2
51 538128>A	2
52 5321369RS/C	1
52 5321369RR/C	1
52 5321369TK/C	1
52 5321369TI/C	1
52 5321369TH/C	1
53 520341	1
54 5321153>A	1
55 547708	1
56 850956/C	1
57 520349LA	1
58 528051	2
59 5321387	1
60 528030	1
61 549090KR>B	1
62 522244AA	1
63 520278	1
64 520178PN	4
65 526145>A	4
67 5321199AC	1
68 518011	1
70 526143RX	2
71 520342AR	2
72 8501028/C	1

66 Light - 150 - Oil levels

Position	Oil type	Quantity (cc)
Right fork leg	SAE 7,5 - 550013	205
Left fork leg	SAE 7,5 - 550013	70

Spare part list - 66 Light - 150

Rif.	Code	Description	Q.ty in the model
1	818370/E	CROWN+STANC.+ALL STEM 66 L'06	1
1	818370/A	CROWN+STANC.+STEEL STEM 66L'06	1
1	818370/R	CROWN+STANCHIONS 66 LIGHT'06	1
2	549098LA	AIR CAP - 66 '06	1
3	701296/C	PLUG UNIT-66'06	1
4	528188	O-RING	2
7	549097AC	AIR CAP+RING -66 '06	1
8	549094LA	REBOUND KNOB '06	1
9	523294	STOP RING	1
10	528265	O-RING	1
11	5321372	ADJUSTER PIN 66 '06	1
12	701288/C	PLUG UNIT- 66 '06	1
13	520220KV	ALLEN BOLT	1
14	5141137>A	SPRING	1
15	525007	SET SCREW, REAR SHOCK	1
20	5141461	REBOUND SPRING 75MM	1
21	509155	FERRULE-66 '06	1
22	523078	STOP RING	1
23	512101	FOOT BUFFER	1
25	547713	EXT.REBOUND ADJ.MTB'06 LABEL	1
25	547711	RC2 - LABEL	1
26	5141330/C	SPRINGS KIT K= 3,2	1
28	5181520	PRELOAD SLEEVE 20MM	1
31	522472	66 PLUG SPACER	1
36	521142IW>A	NUT	1
42	703747LA/C	CARTRIDGE- 66RC '06 TR.170	1
43	523011	STOP RING	1
44	547717 (replaces 547631)	FATTY 2006 LABEL-CHROME	1
44	547665	FATTY LABEL 2006-BLACK	1
44	547690	RH+LH 66LIG'06 LABELS BLK+RED	1
47	533167	DUST SEAL DIA.35	2
48	523236	STOP RING	2
49	528034>B	OIL SEAL DIA.35	2
50	538038>A	UPPER BUSHING DIA.35	2
51	538128>A	LOWER BUSHING DIA.35 H.15	2
52	5321369RS/C	ECO BLK MONOL.DIA.35-66 FORK	1
52	5321369RR/C	FLAT BLK MONOL.DIA.35-66 FORK	1
52	5321369TK/C	PEARL COPPER MONO.D.35-66 FORK	1
52	5321369TI/C	PURE WHITE MONOL.D.35-66 FORK	1
52	5321369TH/C	TRAF.GREY MONOL.DIA.35-66 FORK	1
53	520341	SCREW	1
54	5321153>A	CABLE GUIDE	1
55	547708	EXTER.COMPRESS.ADJUST.-LABEL	1
56	850956/C (replaces R5127LA)	AXLE+SCREW KIT-66/888	1
57	520349LA	AXLE SCREW -QR 20	1
58	528051	O-RING	2

59	5321387	NUT UNIT- 66/888 FORK '06	1
60	528030	O-RING	1
61	549090KR>B (replaces 549090KR>A)	COMPRESSION ALUM. KNOB	1
62	522244AA	WASHER	1
63	520278	SCREW	1
64	520178PN	SCREW	4
65	526145>A	BUSHING	4
67	5321199AC	NUT UNIT - 66 / 888 FORKS	1
68	518011	PRELOAD SLEEVE 25MM	1
70	526143RX	FENDER BUSHINGS	2
71	520342AR	FENDER SCREW	2
72	8501028/C	66 FORK FENDER UNIT MTB 06	1

Exploded view - 66 Light - 170

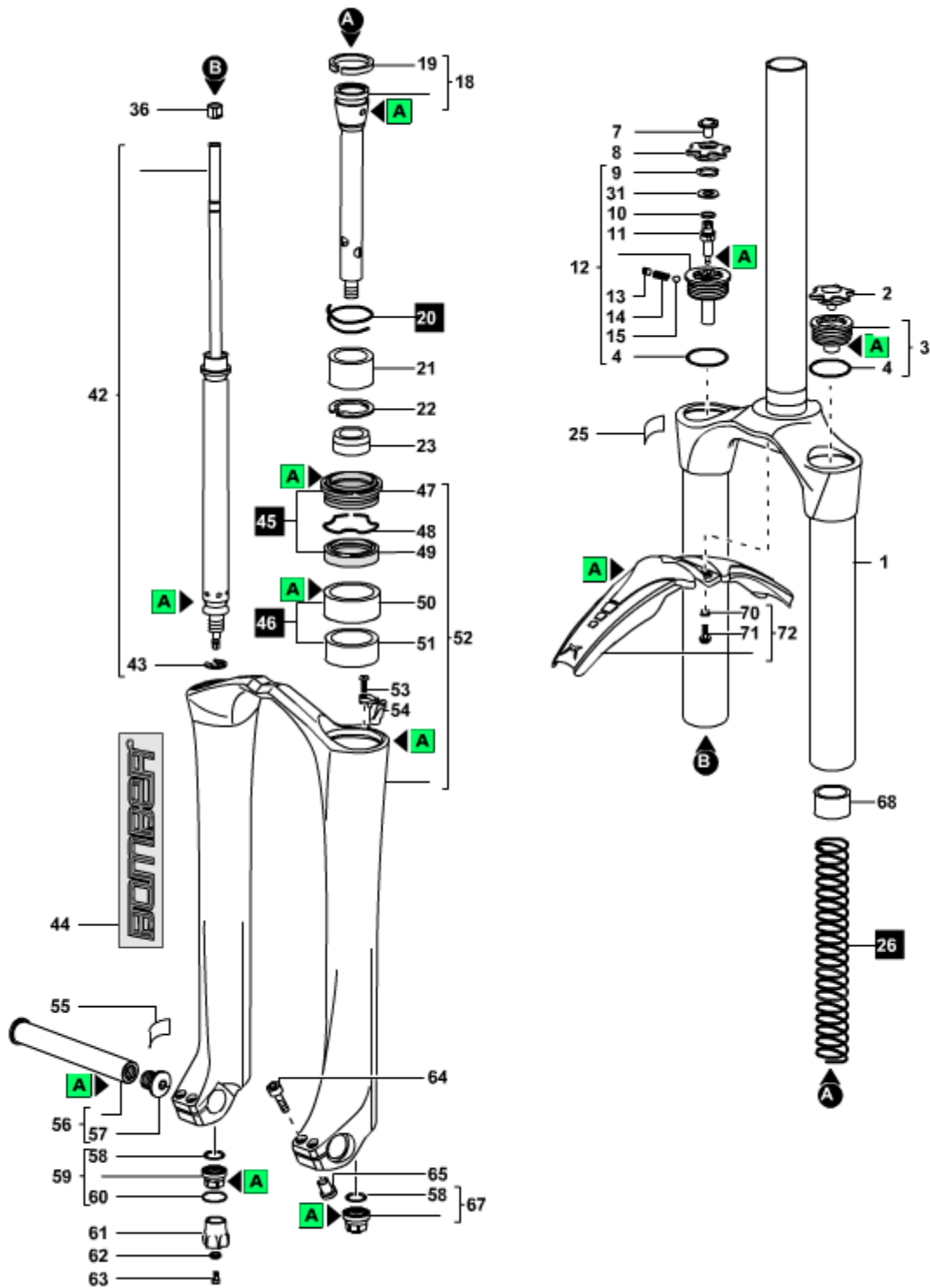

Rif. Code	Quantity
1 818370/E	1
1 818370/A	1
1 818370/R	1
2 549098LA	1
3 701296/C	1
4 528188	2
7 549097AC	1
8 549094LA	1
9 523294	1
10 528265	1
11 5321372	1
12 701288/C	1
13 520220KV	1
14 5141137>A	1
15 525007	1
20 5141461	1
21 509155	1
22 523078	1
23 512101	1
25 547713	1
25 547711	1
26 5141330/C	1
28 5181520	1
31 522472	1
36 5211421W>A	1
42 703747LA/C	1
43 523011	1
44 547717	1
44 547665	1
44 547690	1
47 533167	2
48 523236	2
49 528034>B	2
50 538038>A	2
51 538128>A	2
52 5321369RS/C	1
52 5321369RR/C	1
52 5321369TK/C	1
52 5321369TI/C	1
52 5321369TH/C	1
53 520341	1
54 5321153>A	1
55 547708	1
56 850956/C	1
57 520349LA	1
58 528051	2
59 5321387	1
60 528030	1
61 549090KR>B	1
62 522244AA	1
63 520278	1
64 520178PN	4
65 526145>A	4
67 5321199AC	1
68 518016	1
70 526143RX	2
71 520342AR	2
72 8501028/C	1

66 Light - 170 - Oil levels

Position	Oil type	Quantity (cc)
Right fork leg	SAE 7,5 - 550013	205
Left fork leg	SAE 7,5 - 550013	70

Spare part list - 66 Light - 170

Rif.	Code	Description	Q.ty in the model
1	818370/E	CROWN+STANC.+ALL STEM 66 L'06	1
1	818370/A	CROWN+STANC.+STEEL STEM 66L'06	1
1	818370/R	CROWN+STANCHIONS 66 LIGHT'06	1
2	549098LA	AIR CAP - 66 '06	1
3	701296/C	PLUG UNIT-66'06	1
4	528188	O-RING	2
7	549097AC	AIR CAP+RING -66 '06	1
8	549094LA	REBOUND KNOB '06	1
9	523294	STOP RING	1
10	528265	O-RING	1
11	5321372	ADJUSTER PIN 66 '06	1
12	701288/C	PLUG UNIT- 66 '06	1
13	520220KV	ALLEN BOLT	1
14	5141137>A	SPRING	1
15	525007	SET SCREW, REAR SHOCK	1
20	5141461	REBOUND SPRING 75MM	1
21	509155	FERRULE-66 '06	1
22	523078	STOP RING	1
23	512101	FOOT BUFFER	1
25	547713	EXT.REBOUND ADJ.MTB'06 LABEL	1
25	547711	RC2 - LABEL	1
26	5141330/C	SPRINGS KIT K= 3,2	1
28	5181520	PRELOAD SLEEVE 20MM	1
31	522472	66 PLUG SPACER	1
36	521142IW>A	NUT	1
42	703747LA/C	CARTRIDGE- 66RC '06 TR.170	1
43	523011	STOP RING	1
44	547717 (replaces 547631)	FATTY 2006 LABEL-CHROME	1
44	547665	FATTY LABEL 2006-BLACK	1
44	547690	RH+LH 66LIG'06 LABELS BLK+RED	1
47	533167	DUST SEAL DIA.35	2
48	523236	STOP RING	2
49	528034>B	OIL SEAL DIA.35	2
50	538038>A	UPPER BUSHING DIA.35	2
51	538128>A	LOWER BUSHING DIA.35 H.15	2
52	5321369RS/C	ECO BLK MONOL.DIA.35-66 FORK	1
52	5321369RR/C	FLAT BLK MONOL.DIA.35-66 FORK	1
52	5321369TK/C	PEARL COPPER MONO.D.35-66 FORK	1
52	5321369TI/C	PURE WHITE MONOL.D.35-66 FORK	1
52	5321369TH/C	TRAF.GREY MONOL.DIA.35-66 FORK	1
53	520341	SCREW	1
54	5321153>A	CABLE GUIDE	1
55	547708	EXTER.COMPRESS.ADJUST.-LABEL	1
56	850956/C (replaces R5127LA)	AXLE+SCREW KIT-66/888	1
57	520349LA	AXLE SCREW -QR 20	1
58	528051	O-RING	2

59	5321387	NUT UNIT- 66/888 FORK '06	1
60	528030	O-RING	1
61	549090KR>B (replaces 549090KR>A)	COMPRESSION ALUM. KNOB	1
62	522244AA	WASHER	1
63	520278	SCREW	1
64	520178PN	SCREW	4
65	526145>A	BUSHING	4
67	5321199AC	NUT UNIT - 66 / 888 FORKS	1
68	518016	PRELOAD SLEEVE 40MM	1
70	526143RX	FENDER BUSHINGS	2
71	520342AR	FENDER SCREW	2
72	8501028/C	66 FORK FENDER UNIT MTB 06	1

Technical characteristics: Technical characteristics

Single-crown fork with $\varnothing 35$ mm legs.

Available travels: 150 mm, 170 mm.

Right fork leg damping element: air.

Left fork leg damping element: spring (air pre-load).

Right fork leg damping system: RC2 cartridge with external adjustment of rebound and compression.

Left fork leg damping system: pumping element.

The stanchion tubes are pressed into the crown with a cryogenic process.

Lubrication and cooling of the parts subject to friction with a specially formulated oil.

Steer tube: steel or (optional) reinforced aluminium, 1-1/8", threadless.

Crown: aluminium alloy forged and CNC machined.

Stanchions: anodised aluminium.

One-piece assembly: made of magnesium alloy cast and CNC machined for lighter weight and more stiffness.

Sliding bushings: made of friction-free and wear-free material.

Seals: computer designed oil seals that guarantee maximum seal in any condition.

Oil: specially formulated oil that prevents foam and keeps the viscosity unchanged while offering high performance; free from static friction.

Dropout type: motocross type wheel axle support, with advanced axle and double screw locking system on both dropouts (specific wheel axle, \varnothing 20 mm, supplied).

Disk brake mount: Post Mount for 6" disk (fitting the special adapter supplied by the brake system manufacturer you can install the 8" disk).

Max wheel size: 2.8" x 26".

Integrated fender: available as optional.

Warnings: Instructions for use

MARZOCCHI forks are based on an advanced technology coming from the company's years long experience in the professional mountain bike industry.

For the best results, we recommend inspecting and cleaning the area below the dust seal and the stanchion tube after every use and lubricating the parts with some silicone oil.

MARZOCCHI forks usually offer the best performances since the very first rides. Notwithstanding this, a short running-in period may be necessary (5-10 hours) to adjust the internal couplings. This precaution will lengthen your fork's life and guarantee its best performances.

We recommend changing the oil at least every 100 hours.

The forks with a polished finish must be treated periodically with polishing paste to keep the exterior shining like new.

Warnings: General safety rules

After disassembling the forks, always use new, original Marzocchi seals when reassembling.

To tighten two bolts or nuts that are near each other, always follow the sequence 1-2-1, and tighten to the required tightening torque.

Before reassembly, wash all new and old components and dry them with some compressed air, making sure there are neither breaks nor burrs.

Never use flammable or corrosive solvents when cleaning the forks, as these could damage the fork's seals. If you must use a solvent, use biodegradable detergents that are not corrosive, non-flammable, or have a high flash point.

Before reassembling, always lubricate those components that are in contact with the fork's oil.

If you are planning not to use your forks for a long period of time, always lubricate those components that are in contact with the fork's oil.

Always collect and keep any lubricants, solvents, or detergents, which are not completely biodegradable in the environment. These materials should be kept in appropriate containers, and disposed of according to local laws.

Always grease the seal lips before reassembling.

All of the components of Marzocchi forks require the use of metric tools. Use only metric tools. Imperial (US) tools may have similar sizes, but can damage the bolts, making them impossible to loosen or tighten.

When using a screwdriver to assemble or disassemble metal stop rings, O-rings, sliding bushings, or seal segments, avoid scratching or cutting the components with the screwdriver tip.

Do not carry out any maintenance and / or adjustment operations that are not explained in this manual.

Only use original Marzocchi spare parts.

Before servicing the fork, we recommend washing the fork thoroughly.

Work in a clean, organized, and well-lit place. If possible, avoid servicing your forks outdoors.

Carefully check to see that your work area is free of dust and metal shavings from any component of the forks.

Never modify your fork in any way.

Warnings: Fitting the fork onto the frame

The fork is supplied with "A-Head Set" steer tube to be cut to size according to frame being used.

Fitting the fork onto the bike frame is a very delicate operation that must be carried out at one of our service centres only.

The assembling on the frame and the adjustment of the steer tube must be carried out following the instructions of the steering set manufacturer.

A wrong installation can be dangerous for the rider.

Marzocchi does not guarantee the assembly and accepts no liability for damage and/or accidents arising from a wrong installation.

The steer tube must be pressed into the crown; its replacement must be carried out by one of our service centres using the adequate tools.

A wrong installation of the steer tube into the crown may cause the rider to lose the control of the bike and lead to serious personal injury.

Warnings: Installing the disk brake

Installing the brake system is a delicate and critical operation that must be carried out by an authorized Marzocchi Service Center.

Marzocchi is not responsible for the installation and accepts no liability for damage and/or accidents arising from this operation.

Improper installation of a disk brake system can overstress the caliper mountings, which may cause the caliper mountings to break, resulting in loss of control of the bicycle, an accident, personal injury, or death. Be sure that the brake system installation is also performed in strict compliance with the instructions provided by the brake system manufacturer.

Improper installation can result in an accident, personal injury, or death.

Use only brake systems that comply with the forks specifications.

Before installing a Post Mount braking system, check that the protection film has been removed from the brake caliper.

After installation check that the tube of the brake system is secured to the special support (A).

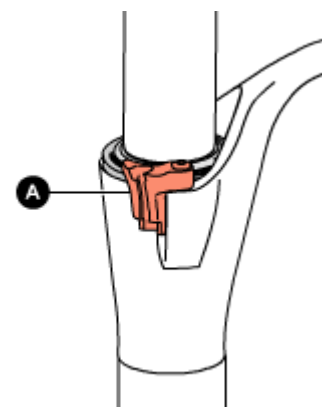

The brake cable must never touch the crown and stanchions.

Warnings: Assembling the fender

The fender can be supplied with the fork or purchased separately.

Fender (1) must be assembled by placing the small support bush (2) between the screw and the fender as shown and by tightening screws (3) with an 8mm fixed spanner to the recommended tightening torque (**6 Nm ±1**).

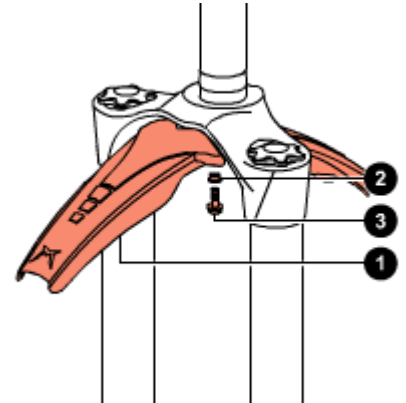

Warnings: Assembling the wheel

For a correct operation of the fork, install the wheel as explained below:

Align the center of the wheel with each wheel axle clamp.

Insert the wheel axle (1) through the right dropout, the wheel and the left dropout.

With the 6mm Allen wrench act on cap (2) and tighten the wheel axle to the recommended tightening torque (**15 Nm ± 1**).

Check for the proper fork-wheel alignment. To do this, begin by fully compressing the fork a few times. The wheel should not make contact with, or come close to any portion of the fork.

Then lift the front of the bicycle and spin the wheel a few times to verify the correct alignment with the disk brake. The wheel should not wobble from side to side or up and down. Check the owner's manual of the brake system for the proper specifications.

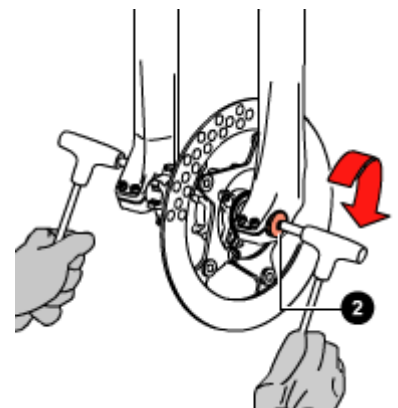
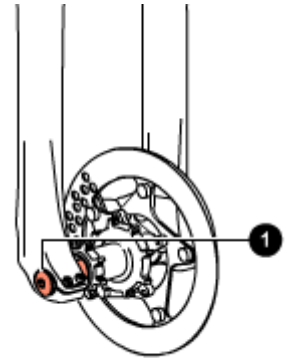

With a 4mm Allen wrench, tighten screws (3) on both dropouts to the recommended tightening torque (**6 Nm ±1**) following the sequence 1-2-1.

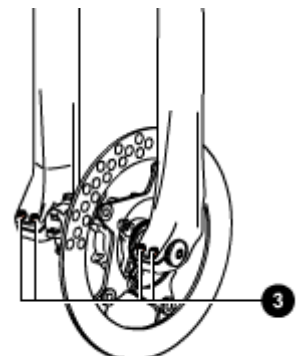

Dismantling: Removing the top caps

Put the fork in the vice in vertical position, fixing it by the dropouts.

Dismantling: Removing the top right cap

Lift the ring (4) of the central cap using a flat screwdriver, if necessary.



By turning ring (4), loosen and remove the central cap (5) and free the protection cap (1).

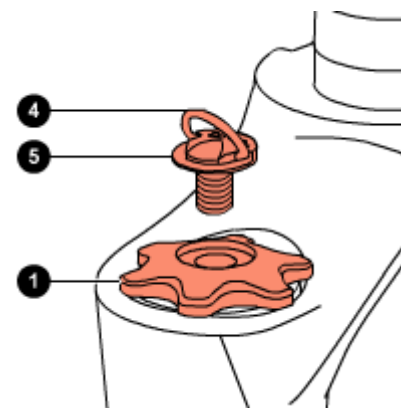

Remove the protection cap (1).

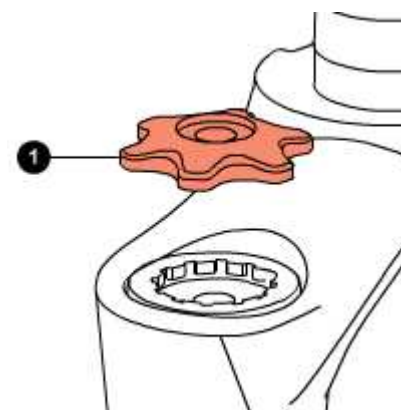

Using a small pin screwdriver, blow the air off the fork leg, pushing on the air valve.
Fully unscrew lock cap (2) with the Shimano TL-LR10 lockring tool.
Remove lock cap (2), being careful not to damage O-ring (3).



Dismantling: Removing the top left cap

Remove the protection cap (1).

Using a small pin screwdriver, blow the air off the fork leg, pushing on the air valve.
Fully unscrew lock cap (2) with the Shimano TL-LR10 lockring tool.
Remove lock cap (2), being careful not to damage O-ring (3).

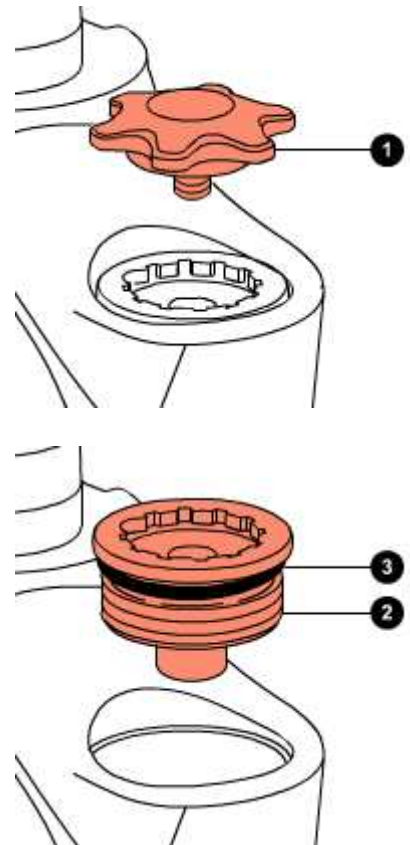

Dismantling: Draining the oil

Remove the preload tube (1) and spring (2) from the left leg.

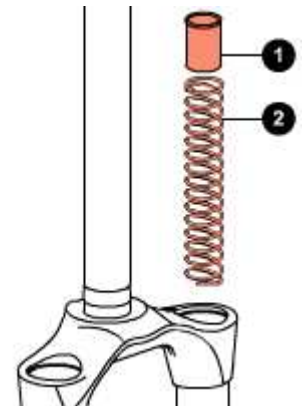

Free the fork from the vice and tip it into a container of a suitable size to drain the oil; compress the fork a few times to help the oil flow out.

Do not pour used oils on the ground.

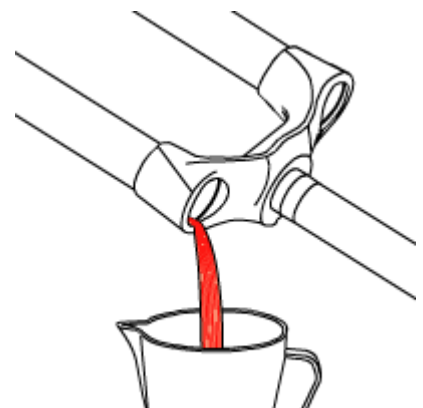

Dismantling: Breaking down the steering crown unit / arch-slider assembly

Use the special spanner to remove the bottom nuts. Do not use other tools.

Turn the arch-slider assembly upside down.

With a 2.5mm Allen key loosen the screw (5) fixing the compression adjustment knob (6) on the right leg.

Remove screw (5), washer (11) and the adjustment knob (6).

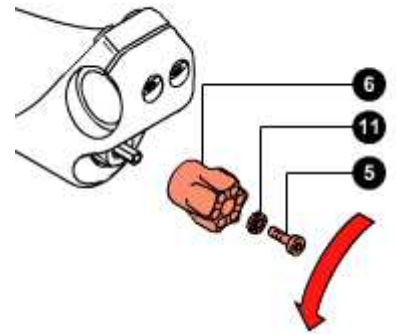

Using the special 12mm spanner (A), loosen the right bottom nut (1).
Pull out the right bottom nut (1) complete with O-ring (2).

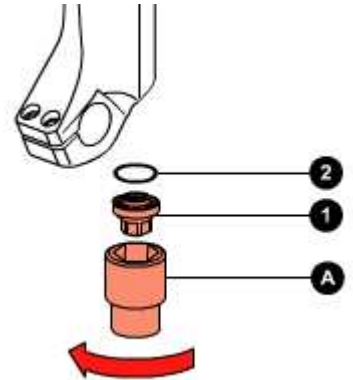

Using the special 15mm spanner, loosen the left bottom nut (1).
Pull out the left bottom nut (1) complete with O-ring (2).

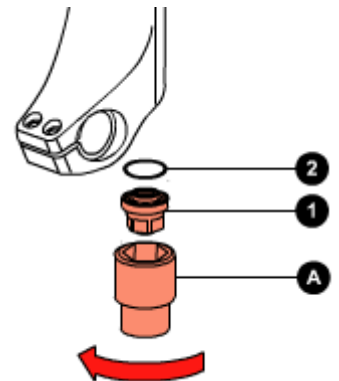

Pull the complete RC2 cartridge (9) off the right leg.

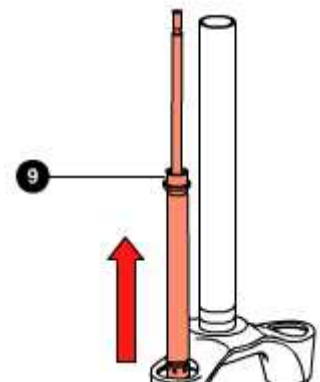

Pull the crown-stanchion unit (3) off the arch-slider assembly (4).

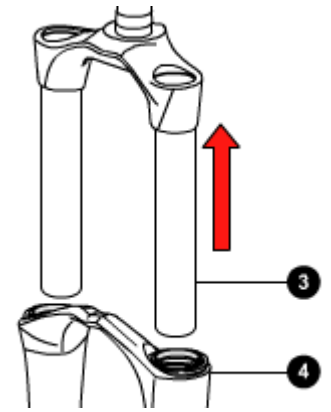

Dismantling: Dismantling the RC2 cartridge

Loosen and remove nut (1) with a 10mm fixed spanner.

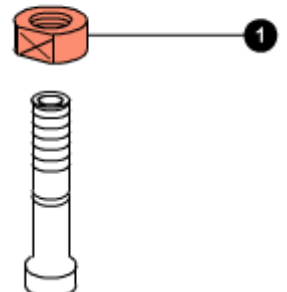

The hydraulic cartridge (5) has been sealed through machining and cannot be overhauled. In the case of faults or a malfunctioning, this cartridge must be replaced.

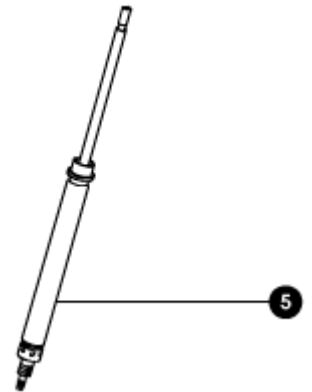

Dismantling: Removing the left pumping element

Remove the bottom pad (1).

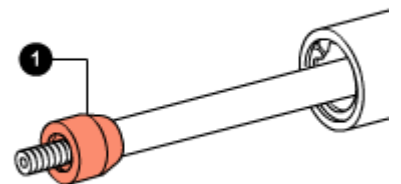

Using the special round-nose pliers, remove stop ring (2).

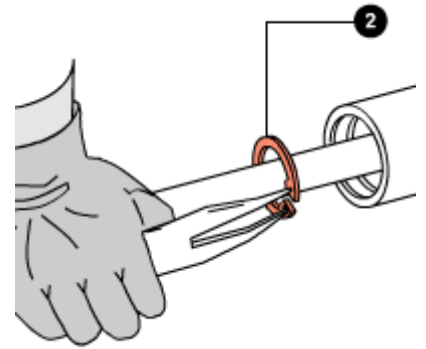

Pull out the pumping element (3) complete with rebound spring and bushing.

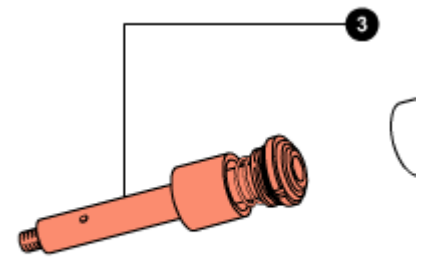

Remove bushing (4), the preload tube (9) (only on models with 150mm travel) and rebound spring (7) from the pumping element.

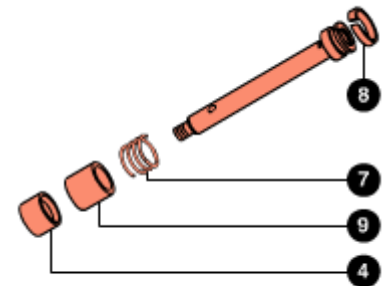

If the piston segment (8) is damaged, you can prize it off with a small flat-tip screwdriver.

Dismantling: Removing the seals

Prize the dust seal (1) off its seat with a small flat-tip screwdriver.

Take great care not to damage the internal surfaces of the one-piece assembly while removing the dust seal.

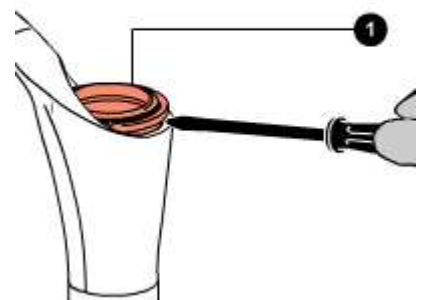

With the same screwdriver, prize off the metal stop ring (2).

Take great care not to damage the internal surfaces of the one-piece assembly while removing the stop ring.

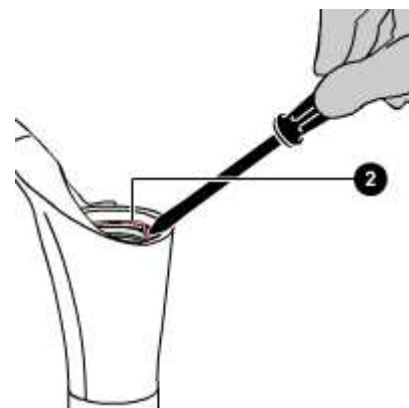

Protect the upper part of the slider with the special tool (A).

With a screwdriver, prize off the sealing ring (3).

Remove the sealing ring (3).

Take great care not to damage the internal surfaces of the one-piece assembly while removing the sealing ring.



The old sealing rings and dust seals must not be used again.

Dismantling: Removing the guide bushes

Use the special extractor to remove the guide bushes. Do not use other tools.

Fit the aluminium bush (A) to the extractor keeping the side with larger diameter towards the edge opposite to striker (D).

Fit the extraction washer (B) with a black finish to the extractor.

During use, remove the non-used washer from the extractor.

Remove first the top bushes, then the bottom bushes.

Fit the extraction washer keeping the blunt side towards the threaded grub screw (C) fixed crosswise on to the main rod as shown.

The slot in the rod lets the extraction washer swing inside the rod itself.

Insert the extractor in the arch-slider assembly from the side of washer (B) as shown.

The slot in the extractor rod will let the washer pass underneath the bush to be extracted.

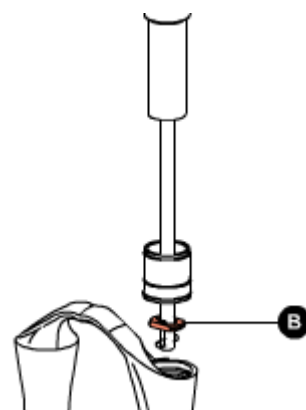
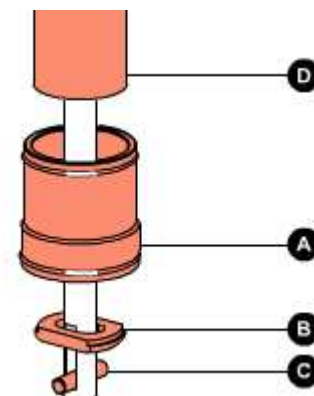

Pull the extractor rod so that the upper face of the washer stops against the lower face of the guide bush.

Insert the aluminium bush (A) in the seat of the sealing ring.

While holding the main rod in position, the aluminium bush will drive the guide bushes during extraction.

Using striker (D) knock out and extract the guide bush (1).

Remove the guide bush (1) from the extractor.

Repeat the steps above to remove the bottom guide bush.

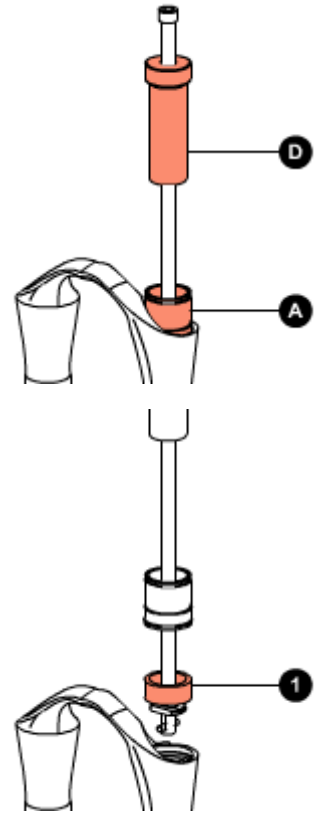

Assembling: Assembling the guide bushes

Insert the guide bushes using the special introducers (short type for the top bush and long type for the bottom bush, both with a white finish). Do not use other tools.

Fit first the bottom bushes, then the top bushes.

Using the long introducer (A) fit the bottom bush (1).

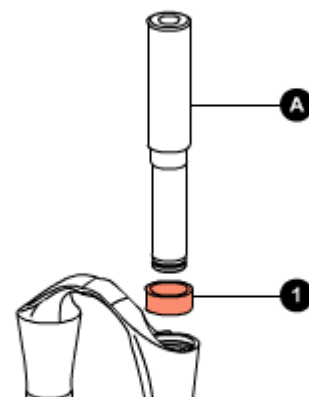

Using a hammer knock the introducer (A) into the arch-slider assembly.

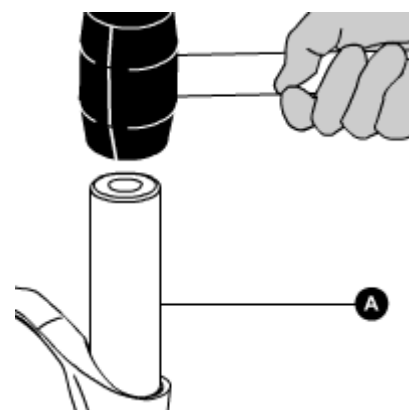

Using the short introducer (B) fit the top bush (2).

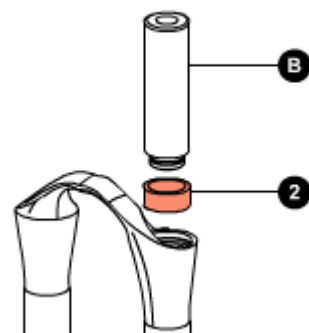

Using a hammer knock the introducer (B) into the arch-slider assembly.

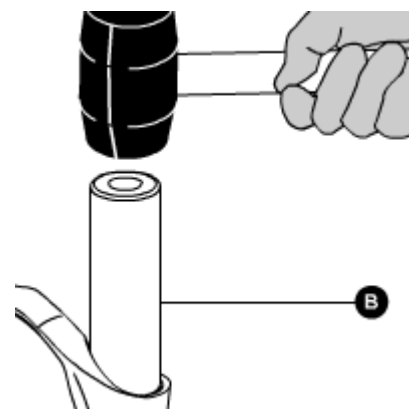

Assembling: Assembling the seals

Smear the dust seal and the sealing ring with some grease.
Insert the sealing ring (3) in its seat with the special introducer (A).

Using a hammer, knock in introducer (A) and drive the sealing ring home into the arch-slider assembly.

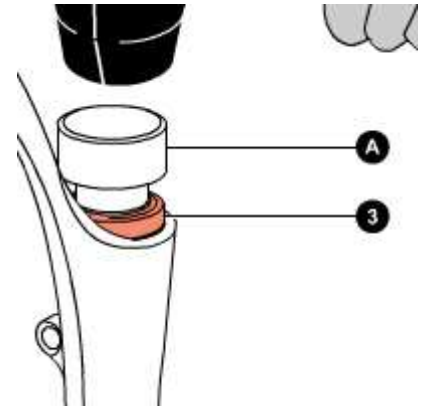

Using a small flat-tip screwdriver, fit the stop ring (2) and check that it fits perfectly into its groove.
Take great care not to damage the internal surfaces of the one-piece assembly when fitting the stop ring.
The dust seals shall be refitted when reassembling the crown-stanchion unit / arch-slider assembly.

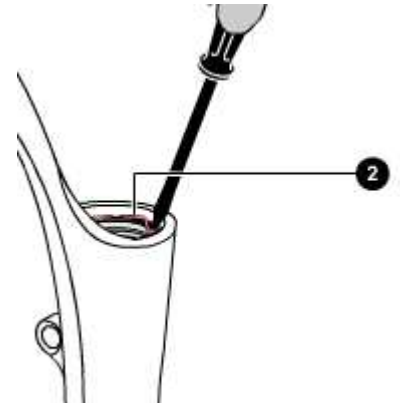

Assembling:

During the assembly of the pumping unit, strictly obey the instructions below.

Do not, at any times, reverse the position of the pumping elements in the fork legs (if you are unsure about anything, please refer to the relevant exploded view).

Assembling: Assembling the RC2 cartridge

Screw down nut (1) without tightening.

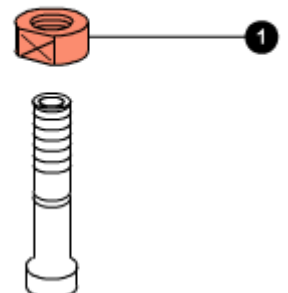

Assembling: Assembling the left pumping element

Replace the segment (8) of the pumping element, if necessary.

Insert the rebound spring (7), the preload tube (9) (*only on models with 150mm travel*) and bushing (4) into the piston rod.

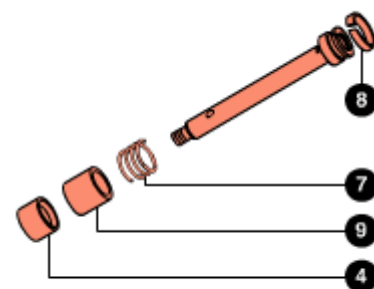

Insert the bushing in the piston rod through the hole with smaller diameter.
Insert the pumping element (3) into the stanchion.

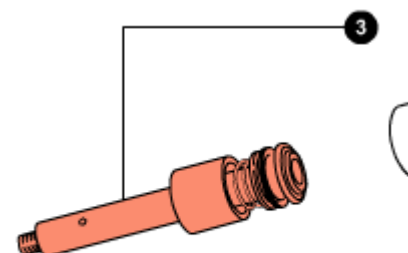

Take great care not to damage the segment and if necessary use a small flat-tip screwdriver to help the piston of the pumping element into the stanchion.

Using the special round-nose pliers, mount the stop ring (2) and check it fits perfectly into its groove.

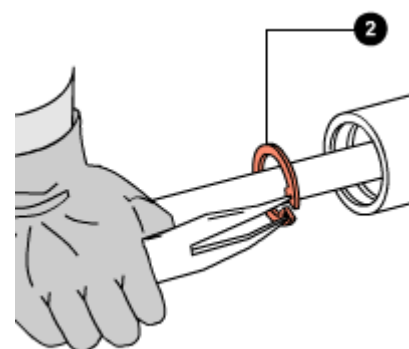

Fit the bottom pad (1) to the pumping element rod.

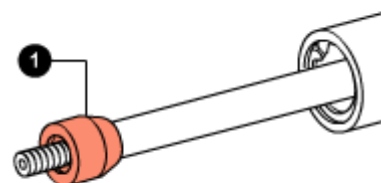

Assembling: Reassembling the steering crown unit / arch-slider assembly

A special spanner shall be used to assemble the bottom nuts. Do not, at any times, use other tools.

Fit both dust seals (11) to the stanchions.

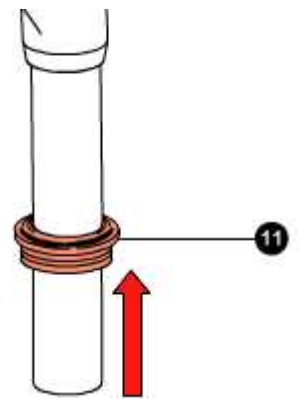

Insert the crown-stanchion unit (3) in the arch-slider assembly (4).

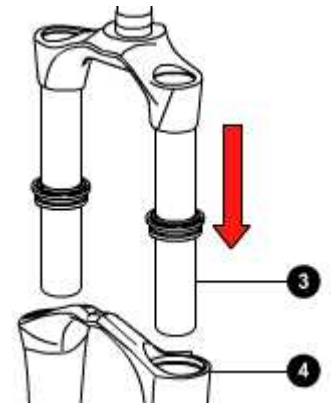

Insert the complete RC2 cartridge (9) in the right leg.

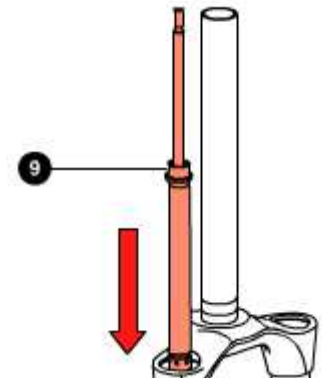

With the special 12mm spanner, tighten the right bottom nut (1) complete with O-ring (2) to the recommended tightening torque ($10 \text{ Nm} \pm 1$).

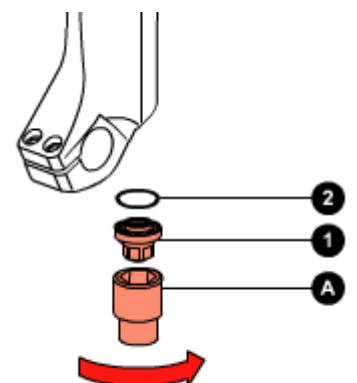

Fit the rebound adjusting knob (6) to the right leg.

Take great care not to damage the O-ring fitted to the end of the pumping element rod.

Tighten the fixing screw (5) of the adjusting knob to the recommended tightening torque ($2 \text{ Nm} \pm 0.5$).

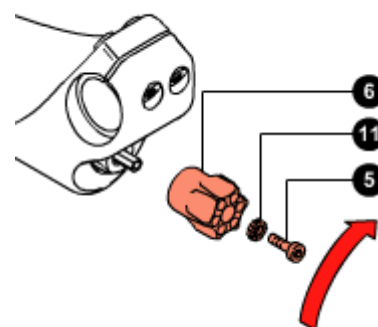

With the special 15mm key, tighten the left bottom nut (1) complete with O-ring (2) to the required torque (**10 Nm ± 1**).

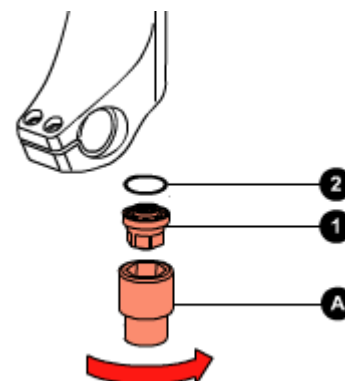

Using introducer (A) insert the dust seals (1) in their seats.

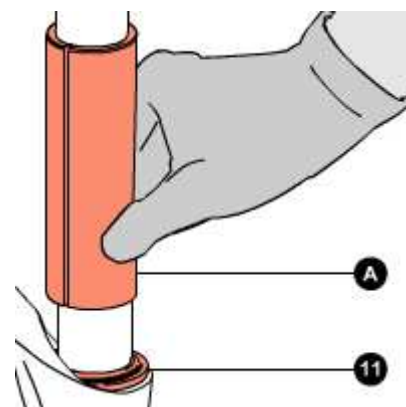

Assembling: Filling with oil

Block the fork in the vice, in perfectly vertical position.

Lower the crown-stanchion unit on the arch-slider assembly.

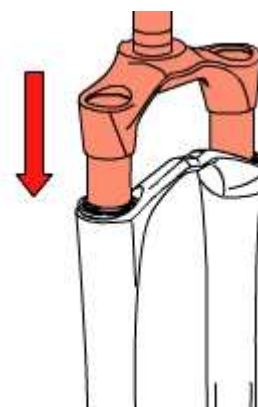

In a graduated recipient, prepare the quantity of oil to pour into the fork leg (see table).

Pour roughly 1/3 of the oil required into each stanchion, then pump the fork a few times to eliminate any traces of air.

Pour the rest of oil in.

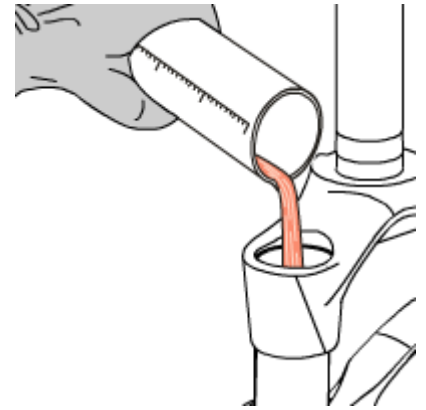

A lower or higher volume or a type of oil other than the one recommended can change the behaviour of the fork in every phase.

Lift the crown-stanchion unit on the arch-slider assembly.

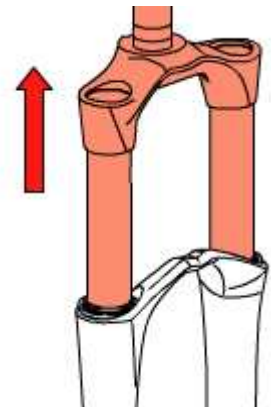

Insert spring (2) and the preload tube (1) in the left leg.

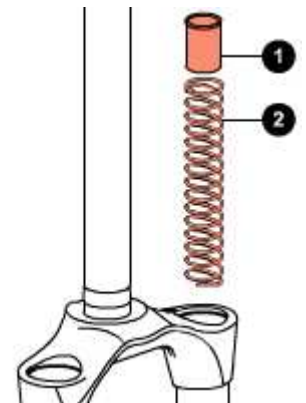

Assembling: Mounting the top caps

Put the fork in the vice in vertical position, fixing it by the dropouts.

Assembling: Assembling the top right cap

Check that O-ring (3) is not damaged.

Using the Shimano TR-RL10 lockring tool, tighten lock cap (2) to the recommended tightening torque (**10 Nm \pm 1**).



Restore the correct air pressure (see settings).

Fit the protection cap (1).

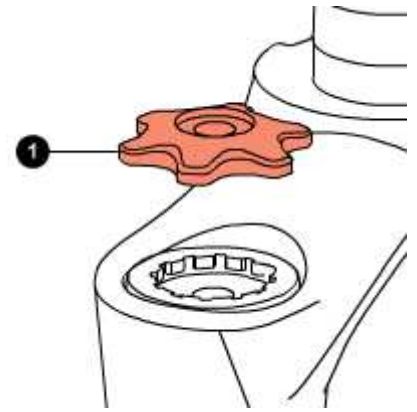

By turning ring (4), screw down the central cap (5) and block the protection cap (1).

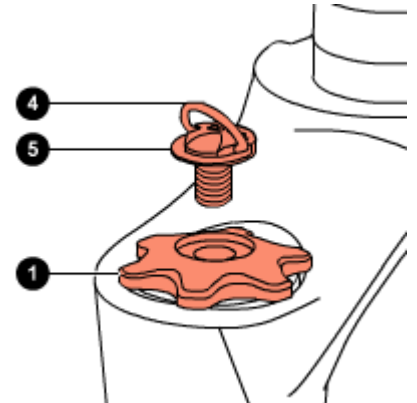

Assembling: Assembling the top left cap

Check that O-ring (3) is not damaged.

Using the Shimano TR-RL10 lockring tool, tighten lock cap (2) to the recommended tightening torque (**10 Nm ± 1**).



Restore the correct air pressure (see settings).

Fit the protection cap (1).

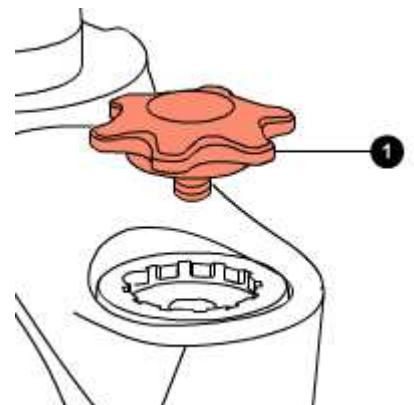

Setting: General rules for calibration

By carefully calibrating the damping system you can get the maximum performance out of the same.

This paragraph indicates the sequence of operations to perform to set up the Marzocchi forks correctly.

In order to find the best settings for you, you will need to try several times to understand where and how to make adjustments. When doing so, please ride in an open area, free from traffic, obstacles and other hazards.

The optimal setting is influenced by the geometry of the frame of the mountain bike, the weight of the cyclist, the type of terrain the bike will be used on and the type of obstacles you have to deal with, but also by subjective factors associated with your riding style; therefore it is impossible to provide objective data on the desired settings.

Nevertheless by carefully following the instructions below you will soon be able to find the optimal setting for you.

The shock absorber must be calibrated simply by using one adjuster at a time, following the order explained, noting the operations and any result step-by-step.

During setting don't force the adjusters beyond their limit of travel and don't exceed the max recommended air pressure.

To keep the pressure inside the fork's legs, only use the special MARZOCCHI pump with pressure gauge.

The use of any other pump can compromise the inflating operation and cause malfunction or damage to the fork, resulting in an accident, personal injury or death.

Once the correct setting has been found, we recommend noting the number of clicks or turns of the adjuster with respect to the "fully closed" position (adjuster fully clockwise) for a faster re-setting of your fork in case of need.

Setting: SAG

SAG means the fork bottoming under the biker's weight.

How to measure the SAG:

Follow these simple steps to measure the SAG.

On the leg portion of the fork, measure the distance between the lower crown and the dust seal (see Picture **A**). Note this value as "**H1**".

While sitting on the bike, repeat the measurement (see picture **B**). Note this value as "**H2**".

SAG = H1 - H2

How to find the best percent SAG:

The best percent SAG is 15-20% for Cross-country and All Mountain forks and 25-30% for Freeride and Downhill forks.

In order to calculate the best SAG for your own fork, you will need to make the following calculation:

SAG = T x S (**T** = total travel; **S** = suggested sinking percentage).

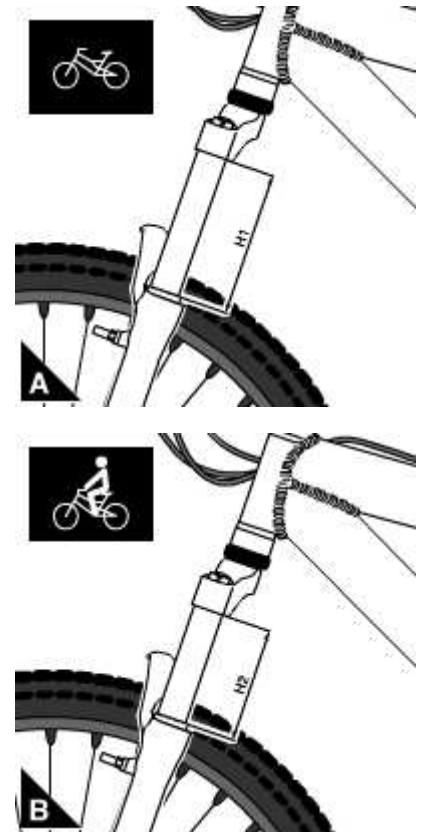

Setting: Positive air

Positive air is the elastic element of air damped forks.

Use the MARZOCCHI pump with pressure gauge to inflate the fork legs.

Using inadequate tools may lead to a wrong inflation and result in a malfunctioning or damage to the fork.

If you need to reduce the leg pressure, simply push the valve pin down with a pointed tool such as a small pin extractor.

Right fork leg:

Remove the rubber protection cap marked with 'AIR' and turn the knob to reach the air valve.

Tighten the threaded pump adapter on the air valve and inflate till reaching the required pressure.

Refit the rubber protection cap and re-calibrate using the adjuster.

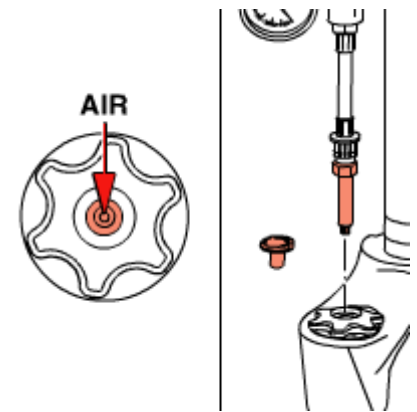

The pressure values in the table are given as a mere example and can be changed to meet the biker's riding style and the track condition.

Setting: Spring preload with air

The optimal spring preloading is the one that lets you obtain the desired SAG under the biker's weight.

Use the MARZOCCHI pump with pressure gauge to inflate the fork legs.

Using inadequate tools may lead to a wrong inflation and result in a malfunctioning or damage to the fork.

If you need to reduce the leg pressure, simply push the valve pin down with a pointed tool such as a small pin extractor.

Left fork leg:

To increase the pressure in the fork leg:

Remove the protection cap.

Tighten the threaded pump adapter on air valve.

Inflate till reaching the pressure you wish (see table).

Refit the protection cap.

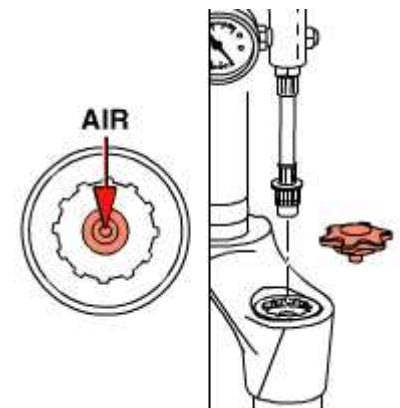

The pressure values in the table are given as a mere example and can be changed to meet the biker's riding style and the track condition.

Setting: Rebound adjustment

Right fork leg:

With the rebound adjuster you can control the return speed of the fork after compression.

The right rebound speed setting makes the bike stable letting it follow the variations in the terrain and any obstacles.

If the fork setting is too reactive this will make the rear suspension instable and the mountain bike will have a tendency to snake. A too slow setting however will cause problems when dealing with multiple obstacles where the suspension can't return to its fully extended position fast enough between one obstacle and the next.

Turning adjuster **(A)** clockwise increases the hydraulic damping making the fork slower during the rebound phase.

Turning adjuster **(A)** counter-clockwise decreases the hydraulic damping making the fork more reactive during the rebound phase.

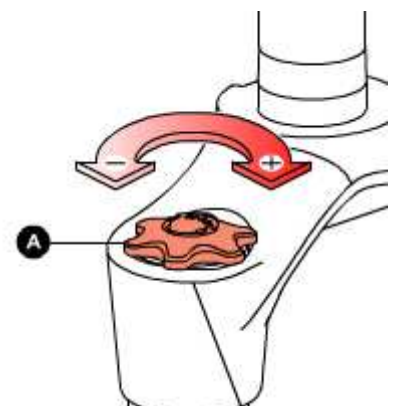

Do not force the adjuster beyond its limit of travel.

Setting: Compression adjustment

Right fork leg:

With the compression adjuster you can control the compression speed.

The compression setting is at the user's discretion and must be set to prevent the suspension bottoming out.

A "hard" compression setting gives you more stability and lets you ride more aggressively making the mountain bike more reactive, vice versa a "soft" setting means less stability but also a less "nervous" ride.

Turning adjuster **(A)** clockwise increases the hydraulic braking during compression and, under the same load conditions, reduces the fork travel.

Turning adjuster **(A)** counter-clockwise decreases the hydraulic compression damping making the fork more reactive on harsh grounds.

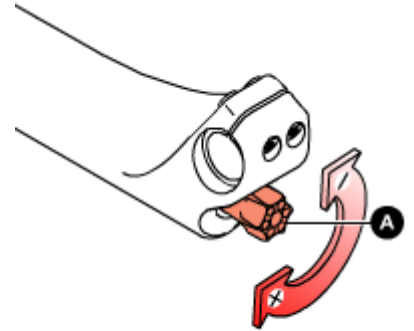

Do not force the adjuster beyond its limit of travel.

Tightening torques

Components	Tightening torque (Nm)
Adjuster locking screws	2±0,5
Fender fixing screws	6±1
Fork leg top caps	10±1
Pumping element/cartridge bottom nuts	10±1
Wheel axle Allen screws	6±1
Wheel axle screws	15±1

Air pressures

Preload air pressure

User weight		Air pressure	
kg.	lb.	bar	psi
0 - 110+	0 - 242	0 - 1,00	0,00 - 1.450,00

66 Light - 150 - Oil levels

Position	Oil type	Quantity (cc)
Right fork leg	SAE 7,5 - 550013	205
Left fork leg	SAE 7,5 - 550013	70

66 Light - 170 - Oil levels

Position	Oil type	Quantity (cc)
Right fork leg	SAE 7,5 - 550013	205
Left fork leg	SAE 7,5 - 550013	70

Diagnostics

Finding the problem	Finding the possible cause	Possible solutions proposed
Fork doesn't get full travel	Oil level too high	Check oil levels
Fork doesn't get full travel	Spring rate too stiff	Change to softer spring rate
Fork doesn't get full travel	Spring rate too stiff	Decrease air pressure
Fork extends too quickly; harsh top-out after impacts	Rebound damping is not enough	Increase rebound damping
Fork extends too quickly; harsh top-out after impacts	Rebound damping is not enough	Replace the oil (SAE 7.5) with one of higher viscosity index
Fork has too much sag	Oil is too fluid	Check oil levels
Fork has too much sag	Spring rate too soft	Change to stiffer spring rate
Fork has too much sag	Spring rate too soft	Increase air pressure
Fork has too much sag	Spring rate too soft	Increase spring preload
Fork has too much sag	Spring rate too soft	Increase spring preload by replacing the preload tube
Fork is "sticky"; fork does not perform as new	Dirty sealing rings; fork needs to be serviced	Renew all seals
Fork is too soft, but the sag is the one recommended	Compression damping is not enough	Increase compression damping by changing oil volumes
Fork is too soft, but the sag is the one recommended	Compression damping is not enough	Increase compression damping with the relevant register
Fork is too soft, needs more than the maximum preload	Oil is too fluid	Check oil levels
Fork is too soft, needs more than the maximum preload	Spring rate too soft	Change to stiffer spring rate
Fork is too soft, needs more than the maximum preload	Spring rate too soft	Increase air pressure
Fork stays down or "packs up" during multiple impacts	Rebound damping is too high	Decrease rebound damping with the relevant register
Front wheel tends to tuck under while turning left or right	Rebound damping is too high	Decrease rebound damping with the relevant register
Front wheel tends to tuck under while turning left or right	Spring rate too soft	Change to stiffer spring rate
Heavy amount of oil on stanchions; oil dripping down legs	Sealing rings damaged	Renew all seals
Heavy amount of oil on stanchions; oil dripping down legs	The stanchion tubes could be damaged	Have the stanchions be checked
Knocking sound during rebound, but no harsh top-out	Rebound damping is too high	Decrease rebound damping with the relevant register
Loss of sensitivity	Old oil	Change the oil
Loss of sensitivity	Sliding bushes worn	Renew the sliding bushes
Oil leaking from the bottom of the fork leg	Bottom nut/screw loose	Tighten the nut or screw
Oil ring on stanchions	Sealing rings dirty	Renew all seals